

- ✓ Dispositif financé 100% par les CEE
- ✓ Fourni, Livré à 0€



Economiseur d'eau tertiaire

Pomme de douche & Mousseur

BAT-EQ-133





Économisez plus d'énergie

Pour les bâtiments à usage tertiaire ou habitat communautaire, recevez vos pommes de douche et vos mousseurs financés à 100% par les certificats d'économies d'énergie (CEE), **fourni livré à 0€.**

Pré requis:

Ne pas avoir déjà bénéficié de ce dispositif dans les six dernières années.

VENTURI - 1 JET

Référence : CEH - 1001



- ✓ Éligible aux CEE reste à charge à 0€ 
- ✓ Fourni, Livré à 0€

 **Garantie**
24 Mois

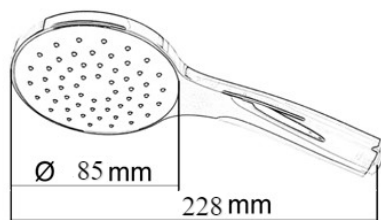
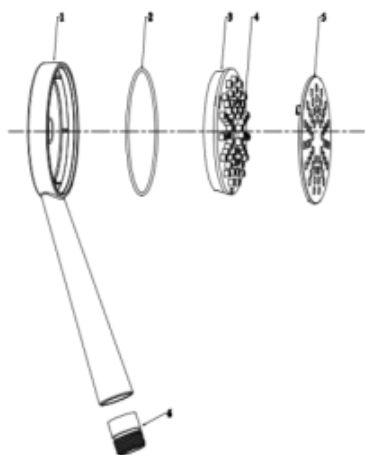

JET : Pluie



Caractéristiques techniques

Dimensions (mm)	228 mm (H)
Dimension tête (mm)	φ85
Poids	94 g
Type de jet	Venturi direct
Fonctions	1 jet
Matériel	ABS
Couleur	Chrome
Pression d'usage	Maximum 7.8bar
Température d'usage	Maximum $\leq (70\pm 2)^{\circ}\text{C}$
Debits - 0.3MPa	5.99 litres minutes
Nettoyage	Picots souples pour nettoyage

VENTURI - 5 JET

Référence : CEH - 1002



- ✓ Éligible aux CEE reste à charge à 0€ 
- ✓ Fourni, Livré à 0€

 **Garantie
24 Mois**

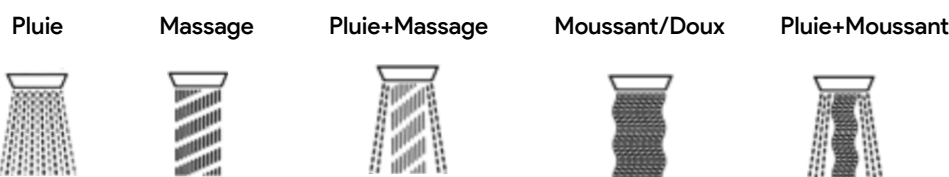
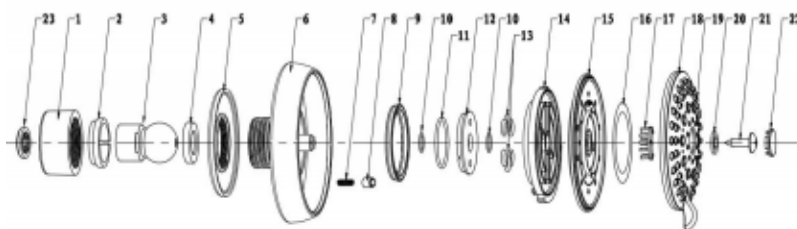

Caractéristiques techniques

Dimensions (mm)	φ98.5*77
Dimension tête (mm)	φ98.5
Poids	168.5 g
Type de jet	Venturi direct
Fonctions	5 jet
Matériel	ABS
Couleur	Chrome
Filetage base	G1/2B
Pression d'usage	Maximum 7.8bar
Température d'usage	Maximum ≤ (70±2)°C
Debits - 0.3MPa	5.99 litres minutes
Nettoyage	Picots souples pour nettoyage

VENTURI - 3 JET

Référence : CEH - 1003



- ✓ Éligible aux CEE reste à charge à 0€ 
- ✓ Fourni, Livré à 0€

 **Garantie
24 Mois**

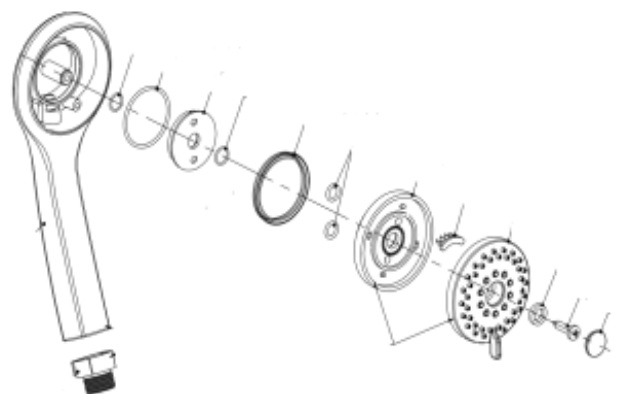
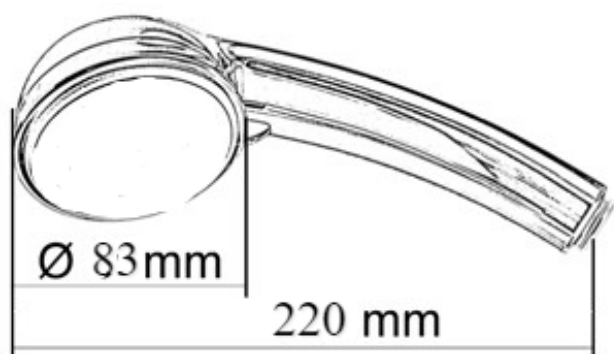

Caractéristiques techniques

Dimensions (mm)	220 mm (H)
Dimension tête (mm)	φ83
Poids	137 g
Type de jet	Venturi direct
Fonctions	3 jet
Matériel	ABS QM 757
Couleur	Chrome
Filetage base	G1/2B
Pression d'usage	Maximum 7.8bar
Température d'usage	Maximum ≤ 90°C
Debits - 0.3MPa	1.5 ≤ Q < 7.2 litres minutes
Nettoyage	Picots souples pour nettoyage



VENTURI - 1 JET

Référence : CEH - 1004



- ✓ Éligible aux CEE reste à charge à 0€ 
- ✓ Fourni, Livré à 0€

 **Garantie
24 Mois**

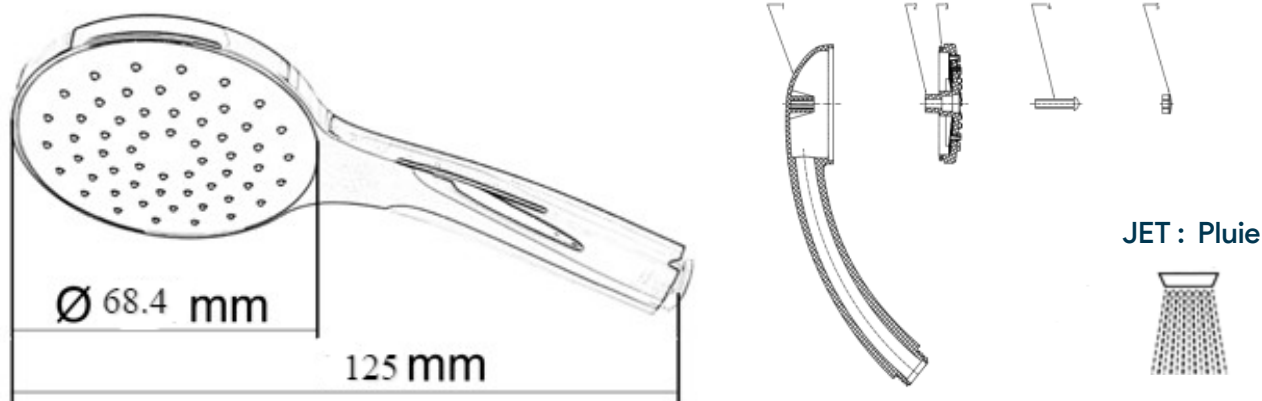

Caractéristiques techniques

Dimensions (mm)	68.4*165*120
Dimension tête (mm)	φ68.4
Poids	117.8 g
Type de jet	Venturi direct
Fonctions	1 jet
Matériel	ABS QM 757
Couleur	Chrome
Filetage base	G1/2B
Pression d'usage	Maximum 7.8bar
Température d'usage	Maximum $\leq (70\pm 2)^{\circ}\text{C}$
Debits - 0.3MPa	5.99 litres minutes
Nettoyage	Picots souples pour nettoyage

Régulateur de jet Aéré autorégulé

Référence : CEH - 1006

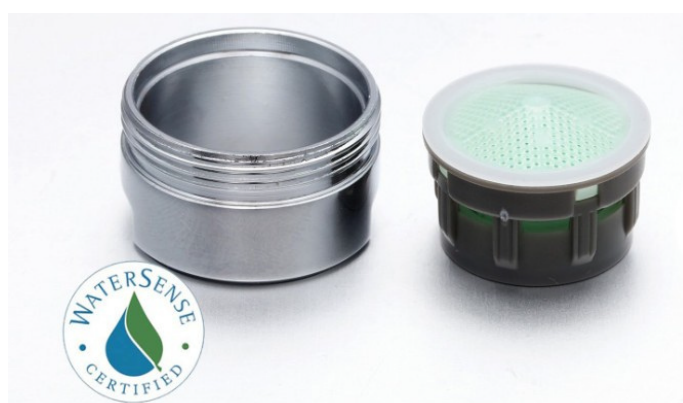

- ✓ Éligible aux CEE reste à charge à 0€ 
- ✓ Fourni, Livré à 0€

 **Garantie
24 Mois**

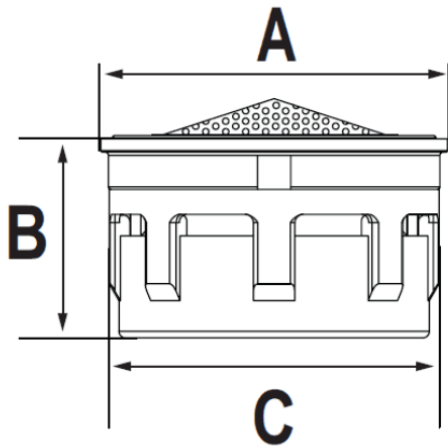

A: 20.88MM

B: 12.40MM

C: 19.85MM

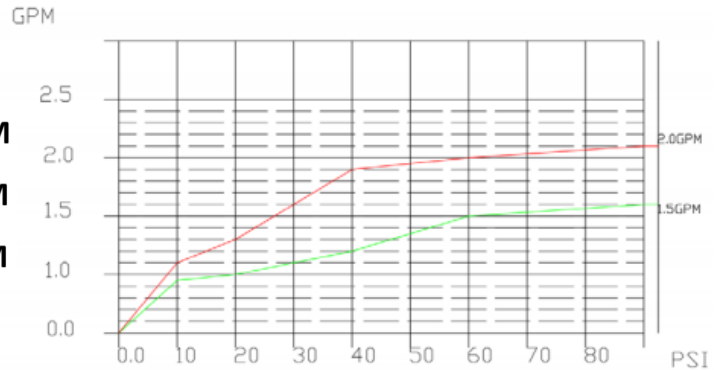

1PSI=0.069BAR

1GPM=3.79L/M

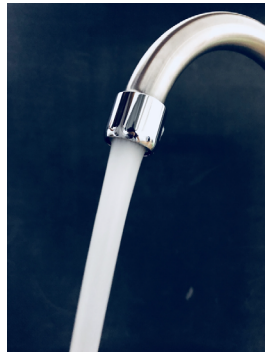
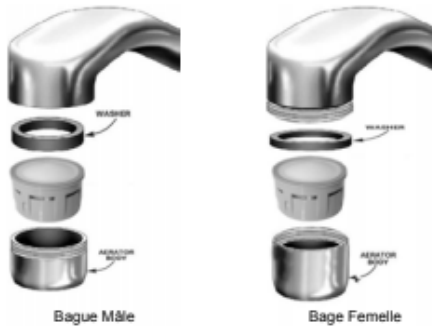

Régulateur de débit Air/Eau
Recharge Mâle/Femelle 22/24x100
ACS
Régulation par membrane souple
Résistance Maxi
Insensible au Calcaire

JET : Pluie

Caractéristiques techniques

Type de jet	Aéré
Filetage	22/24*1
Résistance à la Température	Maximum 120° - 15 min
Debits	Stable - 5.7 litres minutes





www.cee-eco.fr

Conseil Energie Habitat
Siège Social : 9 rue de
Miromesnil 75008 PARIS

Contact
01 76 31 07 39
equipements.cee@conseil-energie-habitat.com